

各種機械的滑動門和搬送最適當的滾輪

· 滾輪由數種類的導溝形狀和不同材質，包括鋼、不銹鋼、工程塑膠、優力膠等製成，客戶可依據用途選擇使用

製品規格

■輕・中荷重規格 (單軸承)

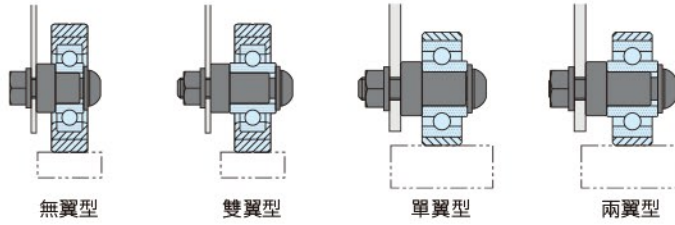

■中荷重規格 (單軸承)

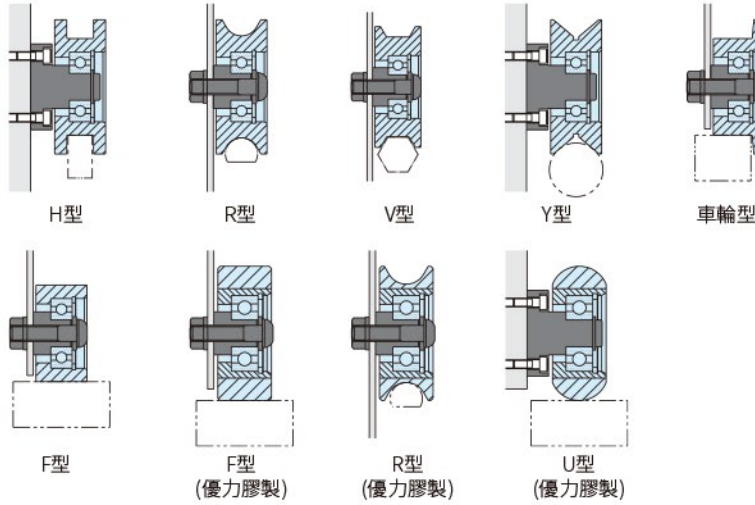

■重荷重規格 (雙軸承)

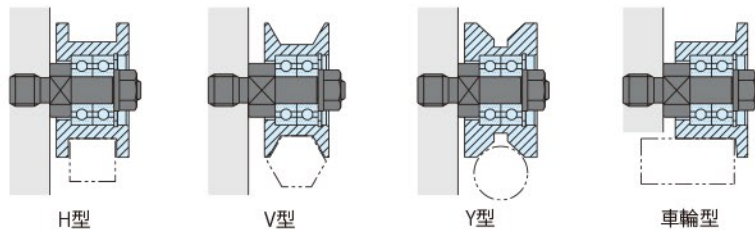

Ex. 使用例

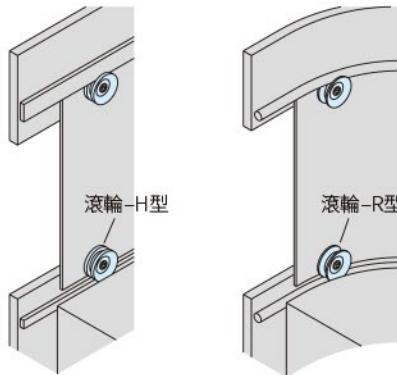

安裝在中心切削加工機和專用機的滑動門

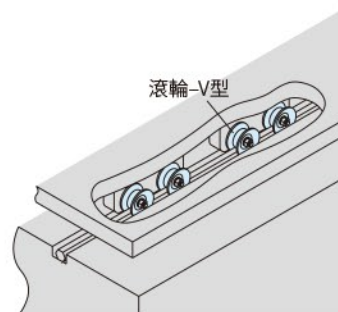

安裝在搬送用的滾輪

製品規格一覽表











■輕荷重規格 (單軸承)

規 格		滾 輪 品 號				
		無 翼 型	對 應 之 滾 輪 銷 品 號		兩 翼 型	對 應 之 滾 輪 銷 品 號
稱呼徑	特殊軸承	優力膠製	鋼 製		優力膠製	
ø20	696-2RS	CTG-BR20	RLP0605		CTG-BR20D	RLP0611
ø25	626-2RS	CTG-BR25	RLP0606		CTG-BR25D	
ø30	608-2RS	CTG-BR30	RLP0807		CTG-BR30D	RLP0813
ø35		CTG-BR35			CTG-BR35D	
ø40	6000-2RS	CTG-BR40	RLP1008		CTG-BR40D	RLP1016
ø45	6201-2RS	CTG-BR45	RLP1210		CTG-BR45D	RLP1216
ø50		CTG-BR50			CTG-BR50D	
ø55	6202-2RS	CTG-BR55	RLP1511		CTG-BR55D	RLP1517
ø60		CTG-BR60			CTG-BR60D	
ø65	6203-2RS	CTG-BR65	RLP1712		CTG-BR65D	RLP1720
ø70		CTG-BR70			CTG-BR70D	
ø75	6204-2RS	CTG-BR75	RLP2014		CTG-BR75D	RLP2018
ø80		CTG-BR80			CTG-BR80D	





■中荷重規格 (單軸承)

規 格		滾 輪 品 號			
		單 翼 型	兩 翼 型		對 應 之 滾 輪 銷 品 號
稱呼徑	特殊軸承	優力膠製	優力膠製		
ø30	W 608ZZ	CTG-BRH30S	CTG-BRH30D		RLP0813
ø35		CTG-BRH35S	CTG-BRH35D		
ø40	W6201ZZ	CTG-BRH40S	CTG-BRH40D		RLP1216
ø45	W6202ZZ	CTG-BRH45S	CTG-BRH45D		RLP1517
ø50	W6904ZZ	CTG-BRH50S	CTG-BRH50D		RLP2018
ø55	W6204ZZ	CTG-BRH55S	CTG-BRH55D		
ø60		CTG-BRH60S	CTG-BRH60D		
ø65	W6205ZZ	CTG-BRH65S	CTG-BRH65D		RLP2521
ø70		CTG-BRH70S	CTG-BRH70D		

■中荷重規格 (單軸承)

規 格		稱呼徑	ø30	ø40	ø50	ø60	ø70		
		軸承品號	606ZZ	608ZZ	6000ZZ	6201ZZ	6202ZZ		
滾輪品號	H型 	鋼製	GRL30S-H	GRL40S-H	GRL50S-H	GRL60S-H	GRL70S-H		
		鋼製熱處理	-	GRL40SH-H	GRL50SH-H	GRL60SH-H	-		
		塑膠製	GRL30J-H	GRL40J-H	GRL50J-H	GRL60J-H	GRL70J-H		
		SUS製	-	GRL40-H-SUS	GRL50-H-SUS	GRL60-H-SUS	-		
	R型 	鋼製	GRL30S-R	GRL40S-R	GRL50S-R	GRL60S-R	GRL70S-R		
		鋼製熱處理	-	-	GRL50SH-R	GRL60SH-R	-		
		塑膠製	GRL30J-R	GRL40J-R	GRL50J-R	GRL60J-R	GRL70J-R		
	V型 	鋼製熱處理	-	-	GRL50SH1-V	GRL60SH1-V	-		
			Y型 	鋼製	GRL30S-Y	GRL40S-Y	GRL50S-Y	GRL60S-Y	GRL70S-Y
				塑膠製	GRL30J-Y	GRL40J-Y	GRL50J-Y	GRL60J-Y	GRL70J-Y
	車輪型 	鋼製	GRL30S-L	GRL40S-L	GRL50S-L	GRL60S-L	GRL70S-L		
			F型 	GRL30S-F	GRL40S-F	GRL50S-F	GRL60S-F	GRL70S-F	
	F型 	優力膠製	塑膠製	GRL30J-F	GRL40J-F	GRL50J-F	GRL60J-F	GRL70J-F	
			R型 	-	GRL40U-R	GRL50U-R	GRL60U-R	-	
U型 			-	GRL40U-U	GRL50U-U	GRL60U-U	-		
對應之滾輪銷品號			鋼製	-	RLP0807F	RLP1008F	RLP1210F	-	
同心 	鋼製	RLP0606	RLP0807	RLP1008	RLP1210	RLP1511			
		SUS製	-	RLP0807-SUS	RLP1008-SUS	RLP1210-SUS	-		
	鋼製	RLP06S	RLP08S	RLP10S	RLP12S	RLP15S			
		SUS製	-	RLP08S-SUS	RLP10S-SUS	RLP12S-SUS	-		
偏心 	鋼製	RLP06E	RLP08E	RLP10E	RLP12E	RLP15E			
		SUS製	-	RLP08E-SUS	RLP10E-SUS	RLP12E-SUS	-		

■重荷重規格 (雙軸承)

規 格		稱呼徑	ø30	ø40	ø50	ø60	ø70
		軸承品號	606ZZ×2	608ZZ×2	6000ZZ×2	6201ZZ×2	6202ZZ×2
滾輪品號	H型 	鋼製	GRL30S2-H	GRL40S2-H	GRL50S2-H	GRL60S2-H	GRL70S2-H
	V型 		GRL30S-V	GRL40S-V	GRL50S-V	GRL60S-V	GRL70S-V
	Y型 	鋼製熱處理	-	-	GRL50SH-V	GRL60SH-V	-
			SUS製	-	GRL40-V-SUS	GRL50-V-SUS	GRL60-V-SUS
車輪型 	鋼製	-	-	GRL50S2-Y	GRL60S2-Y	GRL70S2-Y	
		GRL30S2-L	GRL40S2-L	GRL50S2-L	GRL60S2-L	GRL70S2-L	
對應之滾輪螺柱品號 		RLB0612	RLB0814	RLB1016	RLB1220	RLB1522	